

KARAKTERISTIKE VERTIKALNIH PROFILA - RUKOHVATA

OPŠTE

Svi RAUMPLUS proizvodi se proizvode samo od najkvalitetnijeg aluminijuma. Rukohvati po asortimanu, kvalitetu i raznovrsnosti primene, RAUMPLUS svrstavaju u svetskog lidera na polju kliznih i pregradnih sistema. Ukupno postoje 30 oblika rukohvata u čak 19 standardnih boja i dezena.

GABARITI

Visina: - Teoretski vrata i pregrade mogu biti visine 5,20 metara ili 5.60 metara, obzirom da je to standardna dužina profila.

Debljina: - Postoje rukohvati za sisteme debljine 26mm, 34 mm i 42 mm.

Širina: - Minimalno vidljivi profil je 4 mm, a maksimalni 50 mm.

VRSTE

U zavisnosti od sistema i oblika profila, neki rukohvati se koriste: -za plakare, za pregradjivanje prostorija, umesto vrata na šarke, za izradu montažno-demontažnih fiksnih zidova, za ugradnju bravica, "AIR" visećih kliznih sistema, "Bi-Fold" (harmonika) vrata, za frontove elemenata nameštaja, za ugradnju pod kosinom krova, itd.

PRIMENA

Za sve vrste kliznih i pregradnih sistema enterijera stambenih i poslovnih objekata i prostorija, kao i za zastakljivanje balkona ili kupatilskih i drugih prostorija.

ISPUNA

Ispune mogu biti od drvenih panela (univera), raynih stakala i ogledala, plastičnih materijala, gipsa, metala, tekstila, tapeta i svih drugih materijala debljine od 4 do 10 mm, a uz obodno falcovanje ispuna do 26 mm.

GUMENA DOPUNA

Pomoću gumenih dopuna, tanka stakla i drugi materijali za ispunu debljine 4,5,6 i 8 mm, mogu takodje da se ugrade.

SPECIJALNE OPREMA











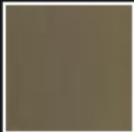

Rukohvati mogu biti nastavljeni pod uglom, ojačani čeličnim profilom iznutra, ugradjene dodatne spoljnje ručke, zalepljene četkice protiv prašine, zalepljenoj dodatni ugaoni profili od 45o, i još mnogo drugih priključaka.

TEHNOLOŠKA OBRADA

Rukohvati se spajaju za horizontalne profile pomoću zavrtnjeva ili vinkli (sistem 4xx). Profili se seku ger-cirkularnom testerom za aluminijum. Bušenje se vrši burgijama za metal ili specijalnim ručnim ili hidrauličnim alatom za izbijanje rupa (serijska proizvodnja). Sve ostale obrade se vrše alatom, opremom i mašinama za drvo i metal.

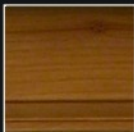
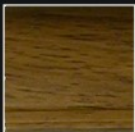
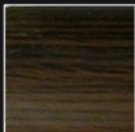
ZAVRŠNA OBRADA PROFILA - DEZEN

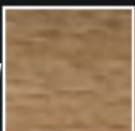
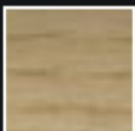
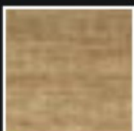
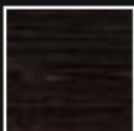
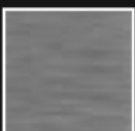
Asortiman standardne završne obrade profila se razlikuje od profila do profila. Donje šine ne mogu biti u FURNMIRANOM i PVC DEZENU.

ELOKSIRANI	 <i>silver</i>	 <i>zlato</i>	 <i>bronz</i>				
LAKIRANI -BOJENI	 <i>belo</i>	 <i>crno</i>					
PVC DEZENI	 <i>jasen</i>	 <i>beljeni hrast</i>	 <i>bukva</i>	 <i>trešnja</i>	 <i>orah</i>	 <i>wenge</i>	 <i>mahagoni</i>
PRIRODNO FURNIRANI	 <i>bukva</i>	 <i>jasen</i>	 <i>anegre</i>	 <i>wenge</i>			
METALNI	 <i>INOX izgled</i>	 <i>hrom sjaj</i>					

SISTEMI VERTIKALNIH PROFILA 34 MM

Svi ovi 34 mm sistemi koriste iste horizontale i šine. Instalaciona dubina: 42 mm (jednokanalna šina), 81 mm (dvokanalna šina), 120 mm (trokanalna šina). *Ovi ekonomski sistemi imaju svoje gornje i donje horizontale, ali koriste iste šine ostalih 34 mm sistema.

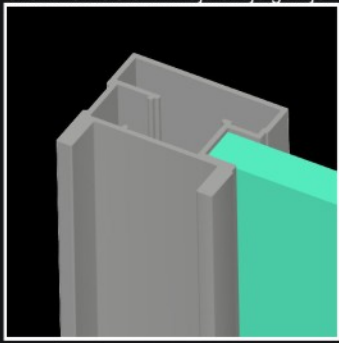

Serija 300 asim.

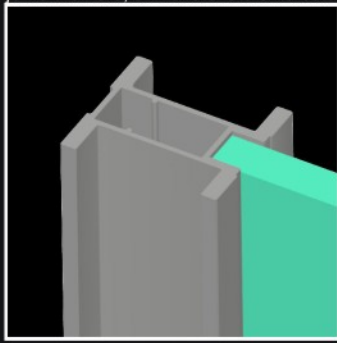

Serija 300 sim.

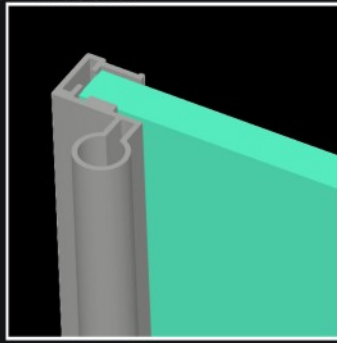

*Serija 410

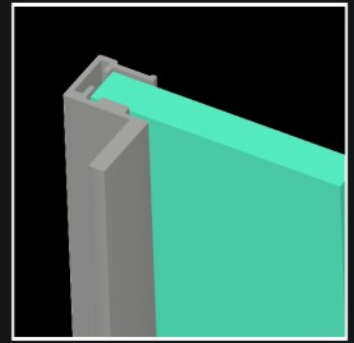

*Serija 420

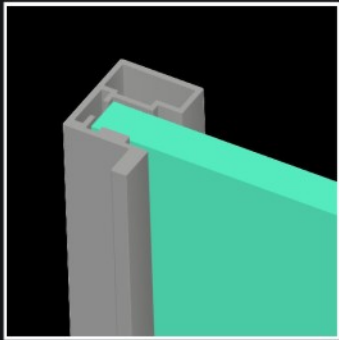

*Serija 440

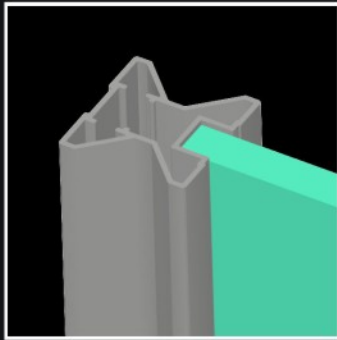

Serija 640

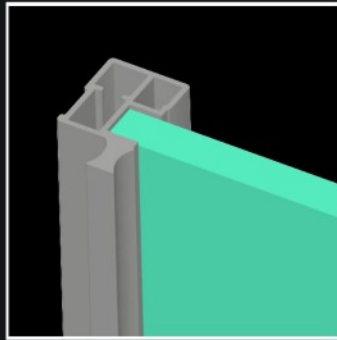

Serija 650

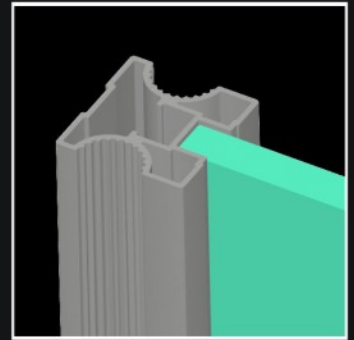

Serija 653

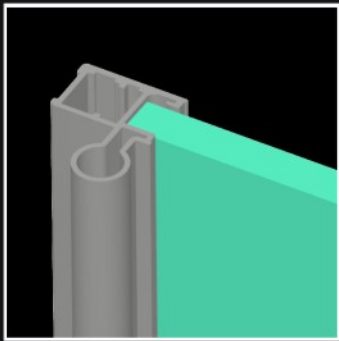

Serija 710

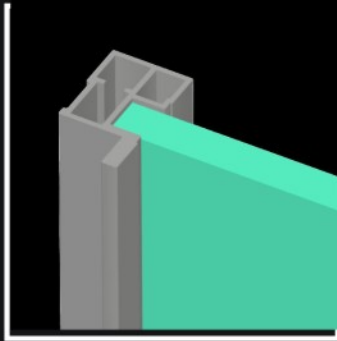

Serija 720

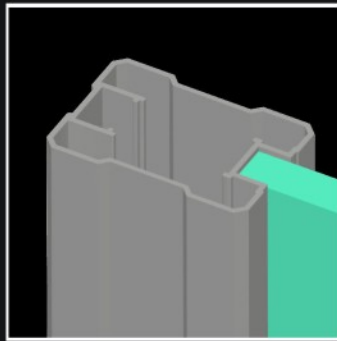

Serija 731

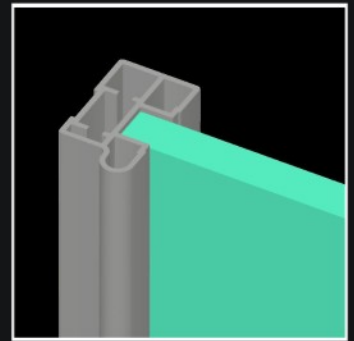

Serija 750 asim.

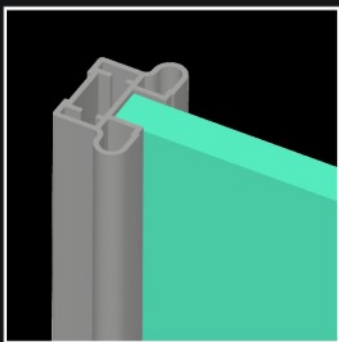

Serija 750 sim

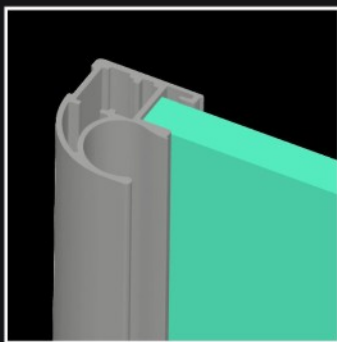

Serija 751

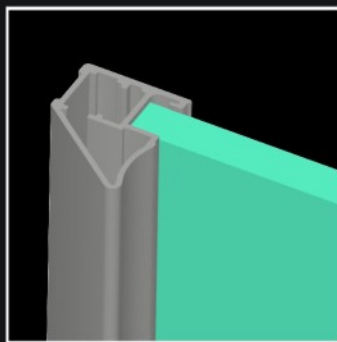

Serija 752.

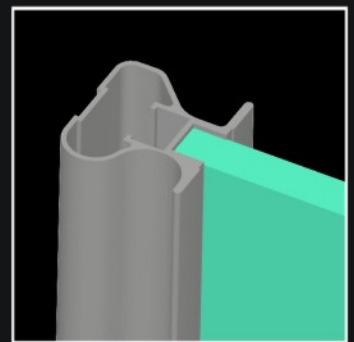

Serija 753

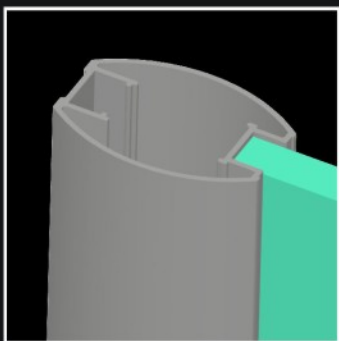

Serija 791 sim

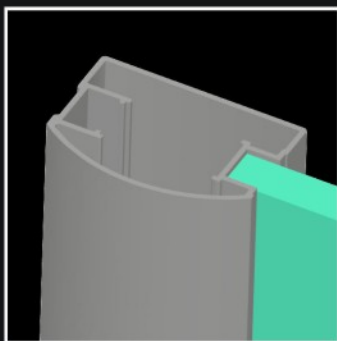

Serija 791 asim.

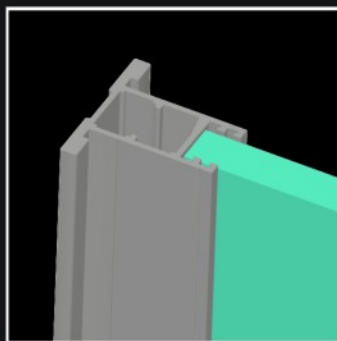

Serija 800 asim.

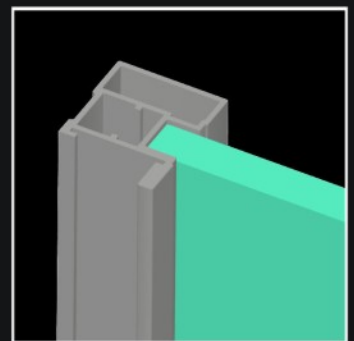

Serija czech

SISTEMI VERTIKALNIH PROFILA 42 MM

Svi 42 mm sistemi koriste iste horizontale i šine. Instalciona dubina: 51 mm (jednokanalna šina), 97 mm (dvokanalna šina), 144 mm (trokanalna šina).

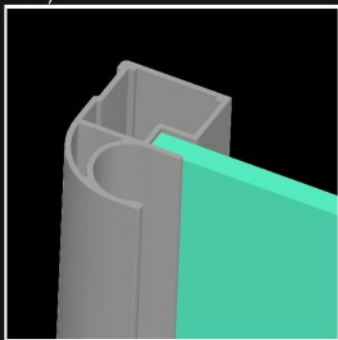

Seriya 1001

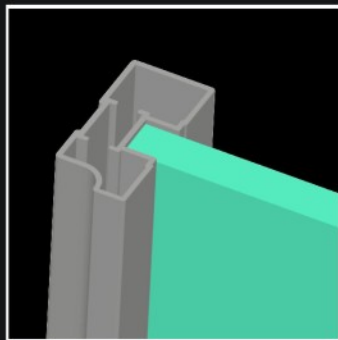

Seriya 1500 asim.

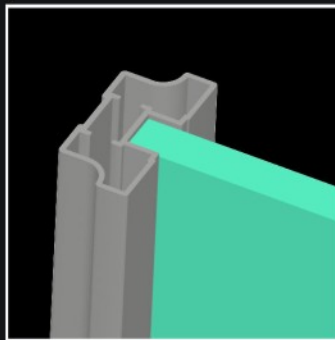

Seriya 1500 sim

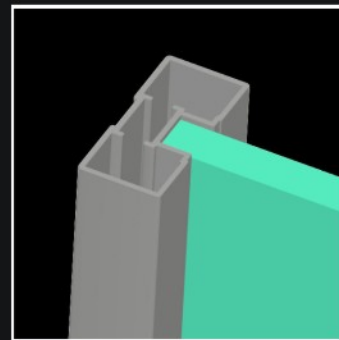

Seriya pravougaoni

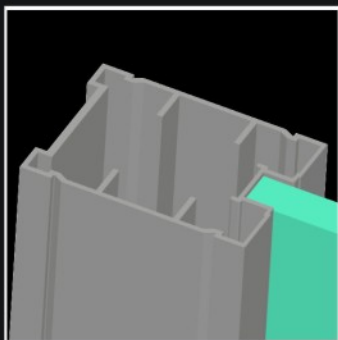

Seriya 1500 wide

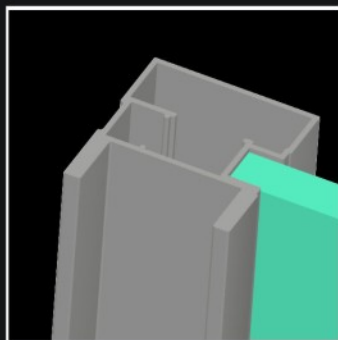

Seriya 3000 asim.

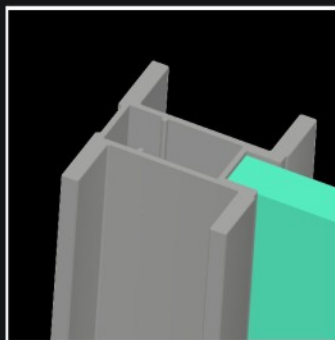

Seriya 3000 sim.

SISTEMI VERTIKALNIH PROFILA 26 MM

Gornje i donje horizontale/ šine S26 sistema su posebno projektovane za ova dva sistema i ne mogu se koristiti za bilo koji drugi RAUMPLUS sistem. Instalciona dubina je 62.2 mm (dvokanalna šina).

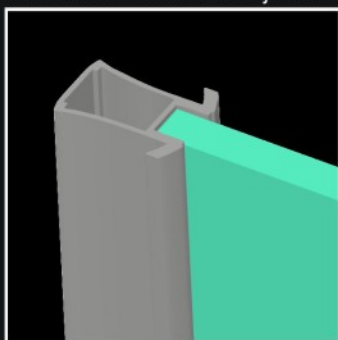

Seriya 26.1

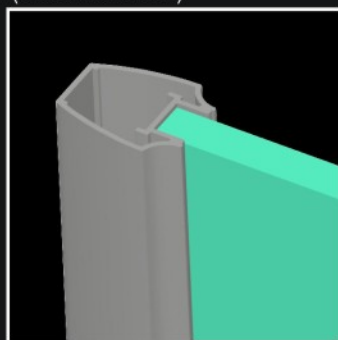

Seriya 26.2

RAMOVSKI PROFILI - FRONTOVI

Profili RP50 su širine 50 mm u koji mogu da se ugrade sve vrste klap šarki kao i klizni mehanizmi. Profili RPB su projektovani za posebne brzo montiraju' šarke. U sve profile mogu da se umetnu stakla od 4 do 5.25 mm.

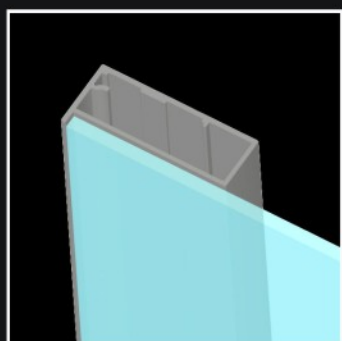

RP50/1 mm

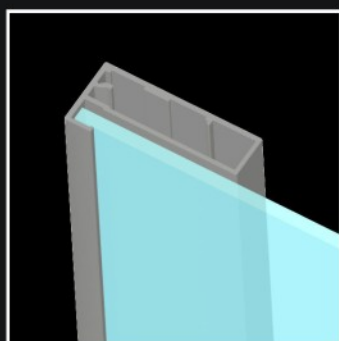

RP50/8 mm

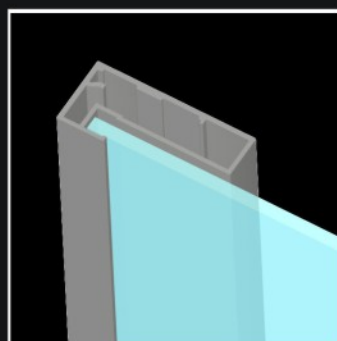

RP50/15 mm

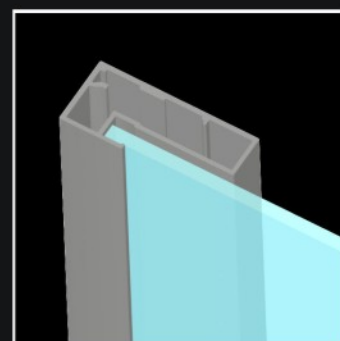

RP50/19 mm

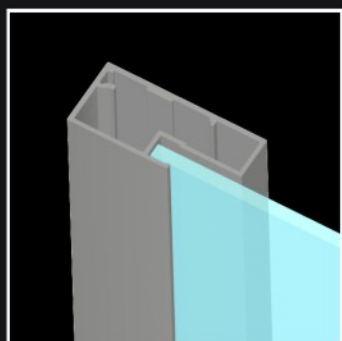

RP50/31 mm

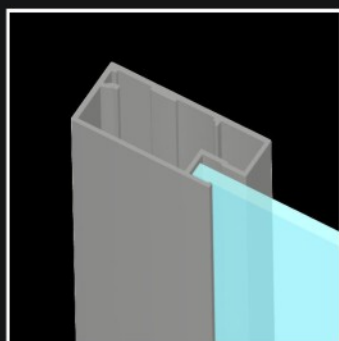

RP50/43 mm

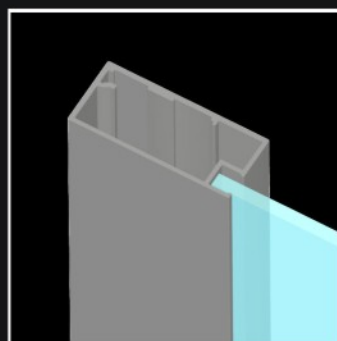

RP50/50

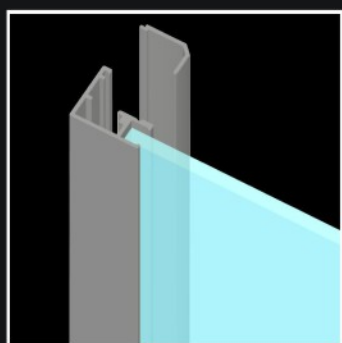

RPB 25mm

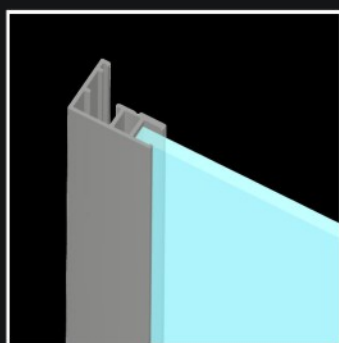

RPB 30 mm

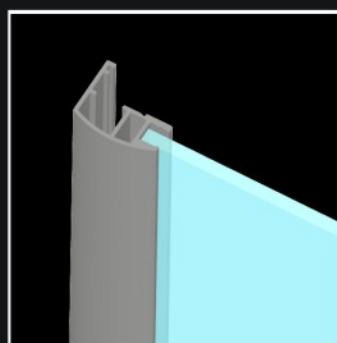

RPB 30 mm zaobljen

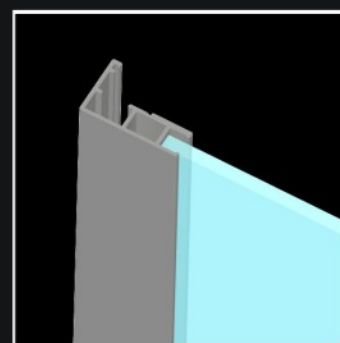

RPB 35 mm.

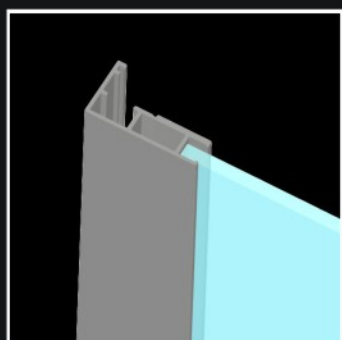

RPB 40 mm

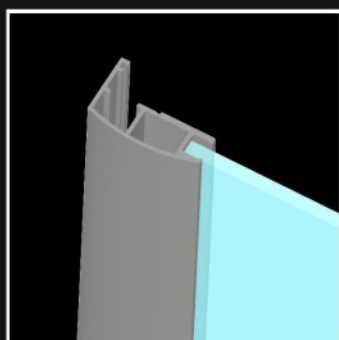

RPB 40 mm zaobljen